

# AXIAL EXITS

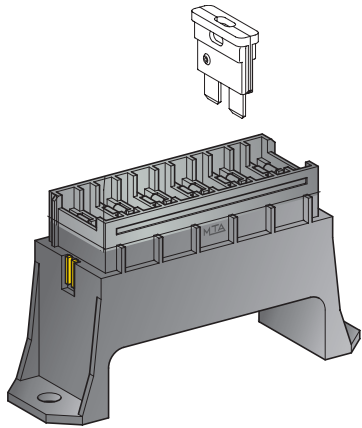

1

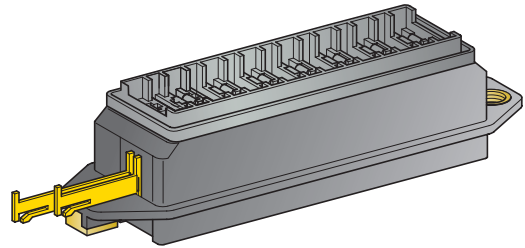

2

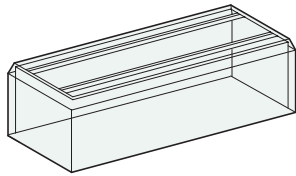

3

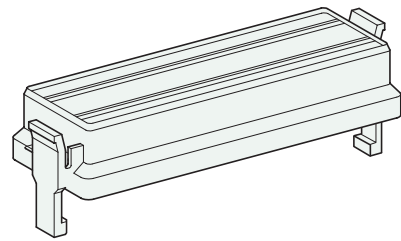

4

IMG	DESCRIPTION	WAY	MATERIAL	COLOUR	P/N KIT WITH COVER AND TERMINALS	M.O.Q.	P/N BULK	M.O.Q.
1	HOUSING WITH TERMINALS	4	PA66 GF30	■ Black	0100540	10	0300540	500
	HOUSING W/OUT TERMINALS	4	PA66 GF30	■ Black				
2	HOUSING WITH TERMINALS	6	PA66 GF30	■ Black	0100560	10	0300560	500
	HOUSING W/OUT TERMINALS	6	PA66 GF30	■ Black				
3	COVER	4	PC	□ Natural			0300542	500
	COVER	6	PC	□ Natural				
4	COVER WITH GASKET	8	PA 12	□ Natural			0300582	150

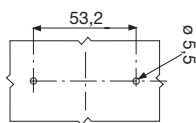

4 WAY

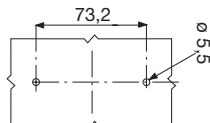

6 WAY

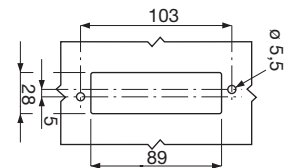

8 WAY

CONNECTIONS AND FIXINGS



UNI F630



UNI F630

IMG	1+2	1+2
-----	-----	-----