

User Manual

Hoymiles MS-A2

1. Packing List



- Immediately contact your supplier or distributor upon noticing any damaged or missing parts.
- In these instructions, the Hoymiles MS-A2 is referred to as "MS-A2" for short.



Hoymiles MS-A2
x1



MS Plug-and-Play Cable
x1



Installation Guide
x1

2. Product Overview

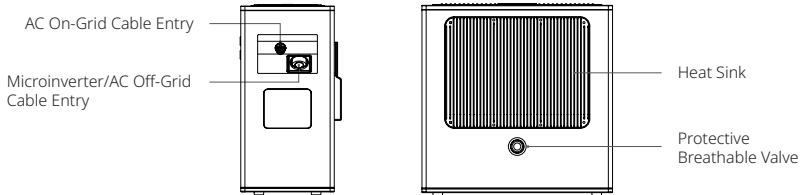
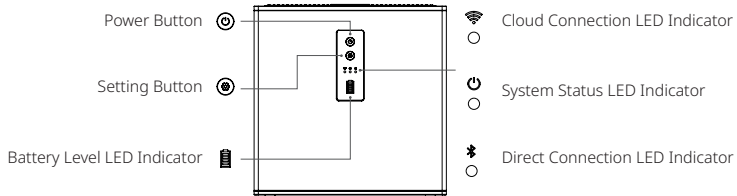









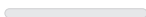

Button Quick Reference Guide

Button	Action	Function
	Press for 2 seconds*.	Turn on the MS-A2.
	Press for 2 seconds.	Turn off the MS-A2.
	Press for 0.5 seconds.	Check the battery level.
	Press for 10 seconds.	Restore the network configuration.
	Press for 5 seconds.	Enable Bluetooth.
	Press for 1 second.	Pair the MS-A2 via Bluetooth.

*: If the MS-A2 is not connected to the grid, press and hold the power button for 8 seconds.

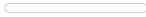
LED Quick Reference Guide

	LED Status	Indications
		Solid white when connected to the S-Miles Cloud.
		Blinking white when connected to the router, but not connected to the S-Miles Cloud.
		Off if no network is available.
		Solid white when the system status is normal.
		Solid red when the device faults.
		Alternating blinking red and blinking white when there's an off-grid port fault.
		Solid white when connected to your phone.
		Off when not connected to your phone.

3. Technical Specifications

AC Output (On-grid Port)	
Nominal output apparent power (VA)	800
Max. output apparent power (VA)	800 ⁽¹⁾
Grid type	Single-phase
Nominal AC voltage/range (V)	230/180 - 270 ⁽²⁾
Nominal AC frequency/range (Hz)	50/45 - 55 ⁽²⁾
Nominal output current (A)	3.48
Max. output current (A)	3.48 ⁽³⁾
Power factor (@Nominal Load)	> 0.99 0.8 leading ... 0.8 lagging
Total harmonic distortion (@Nominal Load)	< 3%
AC Input and Output (Off-grid Port)	
Max. output apparent power (VA)	800
Peak output apparent power (VA)	1200, 10s
Grid type	Single-phase
Connector type	Schuko socket
Nominal AC voltage (V)	230
Nominal AC frequency (Hz)	50
Max. output current (A)	3.48
Total harmonic distortion (@Liner Load)	<3%
Max. input power (VA)	1800
Max. input current (A)	7.83
Battery	
Capacity (Wh)	2240

Cell type	LiFePO4
Life cycles	≥6000
Charging temperature (°C)	0 to 55
Discharging temperature (°C)	-20 to 55
Nominal apparent power (VA)	1000 (charge and discharge)
General	
Weight (kg)	32
Dimensions (L × W × H [mm])	455 × 220 × 457
Mounting	Wall-mounted or Floor-mounted
Cooling	Natural convection-No fans
Wireless type	Bluetooth, 2.4GHz Wi-Fi
Interface	LED & APP
Protection degree	IP65 ⁽⁴⁾
Pollution class	PD3
Over-voltage rating	II
Maximum altitude (m)	2000
Operating temperature range (°C)	-20 to 55
Relative humidity (%)	5 to 95

[1] It can be customized by using the S-Miles Balcony App and can be adjusted up to 1000 VA.

[2] The nominal voltage/frequency range may vary based on local requirements.

[3] It is the ratio of max. output apparent power to nominal AC voltage.

[4] The product is rated IP65 overall, with the exception of the standard AC socket.

4. Installation

4.1 Installation Tools



Rubber Mallet



Marker



Electrical Screwdriver (M5, M6)

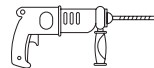

Hammer Drill (φ8)

4.2 Mechanical Installation



- All installations must adhere to local electrical standards and the national electrical code.
- For safe operation and to avoid damage to the device, observe the following requirements when selecting the installation site.
 - **Basic Requirements:** The installation site must be convenient for electrical connection, operation, and maintenance. Additionally, it must be shielded from direct rainfall and sunlight.
 - **Mounting Structure Requirements:** The installation surface must be suitable for the weight (32 kg), dimensions, and cable length of the MS-A2.
 - **Installation Space Requirements:** To ensure air circulation, the installation site must have sufficient air clearances around the MS-A2. Clearances may vary depending on specific installations, and we suggest a general minimum guideline: maintain at least 3.5 mm clearance to the nearest adjacent sidewall on the up, bottom, left, and right sides.

Method 1 Floor-Mounted



The back of the device must be separated from the wall by at least 1 cm.

Position the MS-A2 on a flat and stable surface.

Method 2 Wall-Mounted



The mounting kit (brackets, screws, and expansion bolts) must be purchased separately. You can email our sales team at sales@hoymiles.com to order the mounting kit.

- Choose a location to mount the MS-A2.
- Use a level to ensure the wall-mount bracket is completely level. Then mark drilling positions.
- Drill in the marked positions. (Depth ≥ 50 mm)
- Secure the wall-mount bracket to the wall with the M6 \times 50 expansion screws. (Torque: 9 N·m)

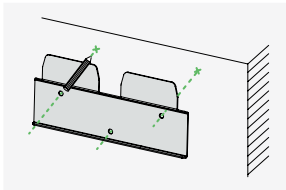

B).

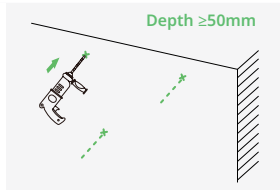

C).

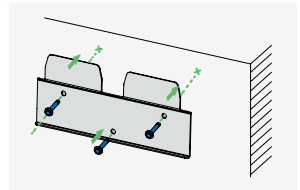

D)-1.

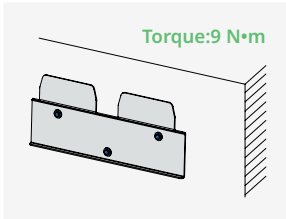

D)-2.

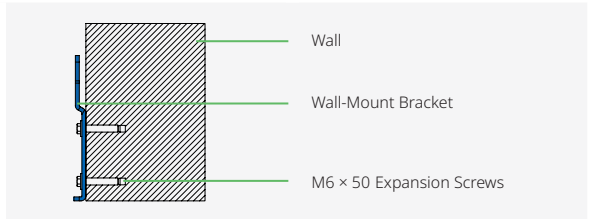

D)-3.

- Install the other mounting bracket into the MS-A2 and secure them using the M5 \times 10 screws. (Torque: 1.5-2 N·m)

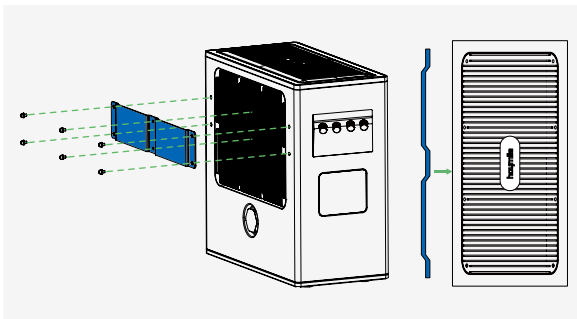

E)-1.

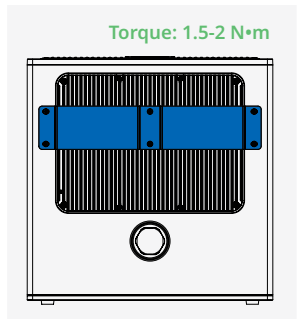

E)-2.

F) Hang the MS-A2 onto the wall-mounted bracket.

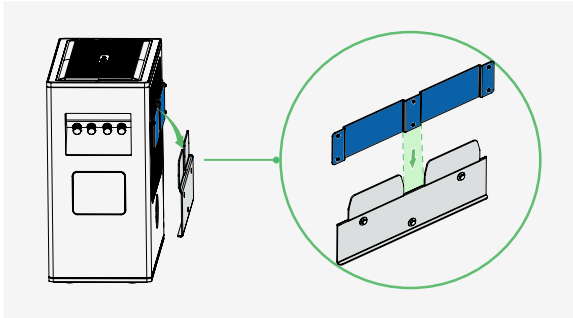

F-1.

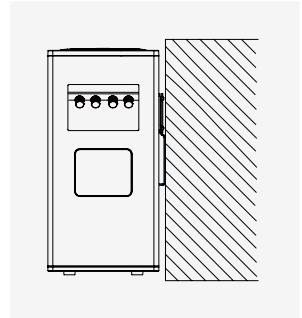

F-2.

4.3 Electrical Connection

DANGER!

Before proceeding with the installation make sure the microinverter system is disconnected from the power supply, the solar panels are shaded or isolated, and the MS-A2 is turned off.

Step 1 Disconnecting the Microinverter System from the Grid

A) Unplug the HMS Plug and Play Cable from the socket.

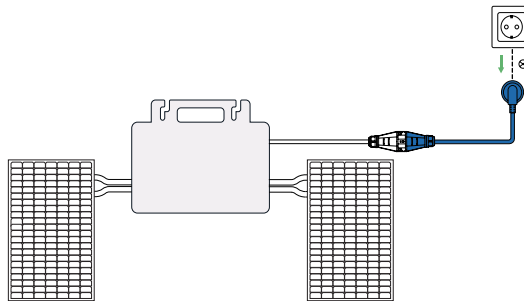

Step 2 Connecting the Microinverter System to the MS-A2

A) Insert the HMS Plug and Play Cable into the AC Off-Grid cable entry of the MS-A2. Listen for a click to ensure proper engagement.

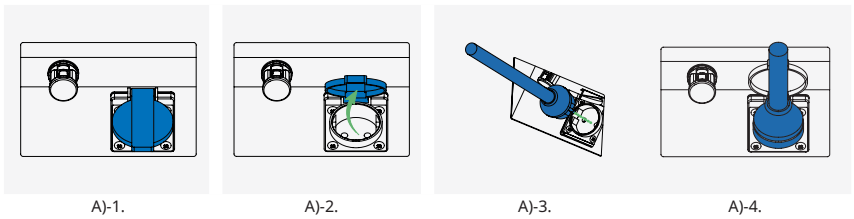
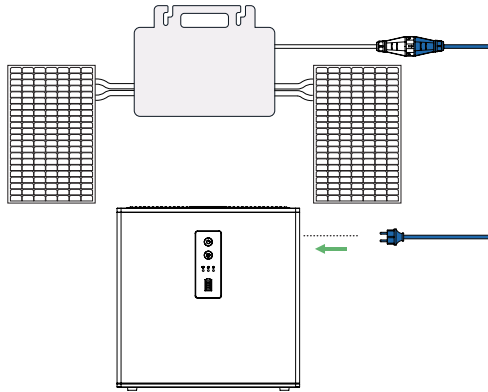

Step 3 Connecting the MS-A2 to the Grid

- A) Insert the MS Plug-and-Play Cable into the AC On-Grid cable entry of the MS-A2. Listen for a click to ensure proper engagement.
- B) Plug the other end of the MS Plug-and-Play Cable into the socket.

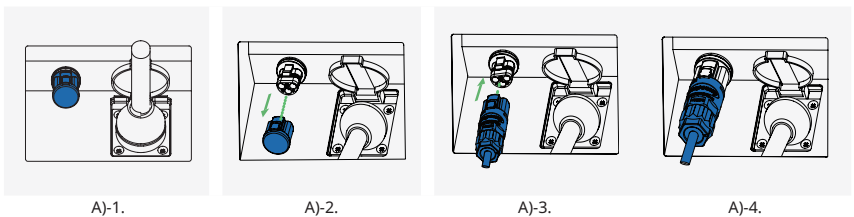
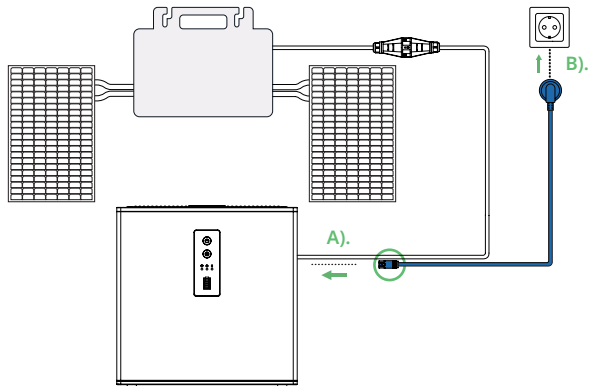

5. Using the MS-A2



- The screenshots provided here are for reference only. The actual screens may vary.
- There are two ways to download the S-Miles Balcony App:
 - Scan the QR code, or
 - Search for "S-Miles Balcony" on the App Store (iOS) or Play Store (Android).



S-Miles Balcony

5.1 Powering on the MS-A2



If the MS-A2 is not connected to the grid, press and hold the power button  for 8 seconds.

- Press and hold the Power Button  for approximately 2 seconds.
- Upon powering on, the device status indicator  will blink white.

5.2 Creating an Account

- Open the app and tap the **Register** button.
- Enter your details and select the required checkbox. Then tap the **Register** button to complete registration.

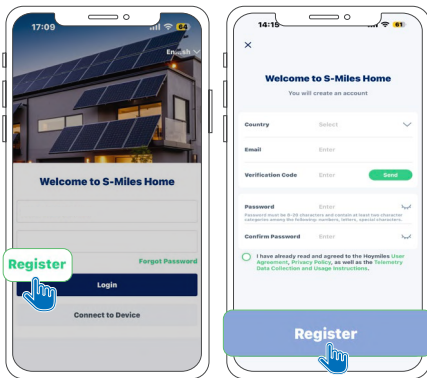

A).

B).

5.3 Connecting the MS-A2 to the S-Miles Cloud

- A) Launch and log in to the app using your credentials.
- B) Go to **Devices > Add Devices**. A pop-up dialog will prompt you to enable your phone's Bluetooth.
- C) Follow the on-screen instructions to connect the MS-A2 to the S-Miles Cloud.

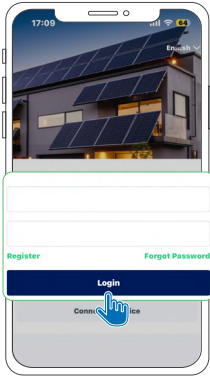

A).

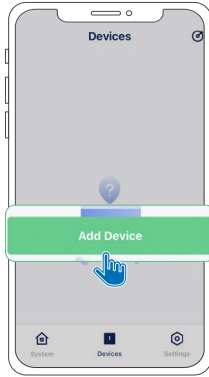

B)-1.

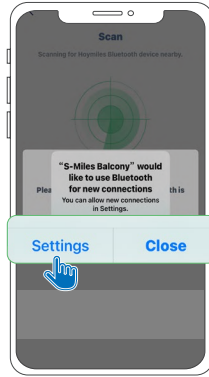

B)-2.

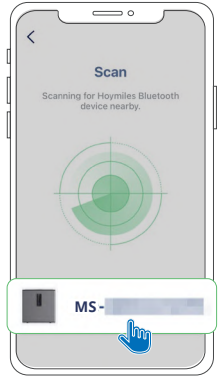

C)-1.

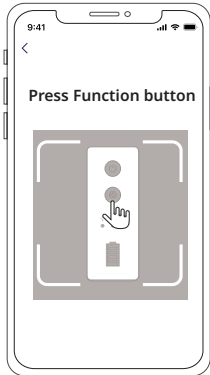

C)-2.

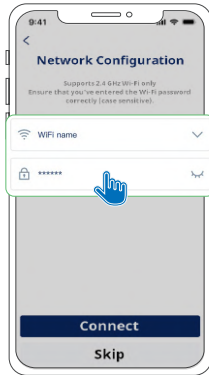

C)-3.



C)-4.

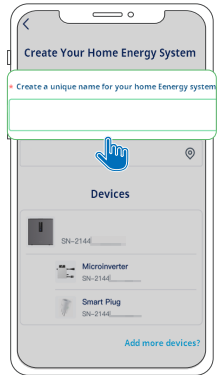

C)-5.

5.4 Setting the MS-A2

A) On the **Devices** screen, tap the device. You will be directed to the device homepage.

B) On the device homepage, tap the setting icon .



A).



B)-1.

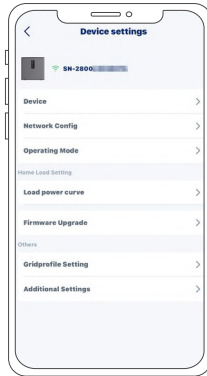

B)-2.

C) To set the output power,

1) Go to **Device settings** > **Additional Settings**.

2) On the **Additional Settings** screen, drag the slider to the right to increase the output power.

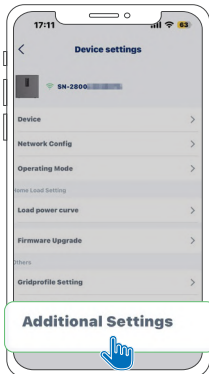

C)-1.

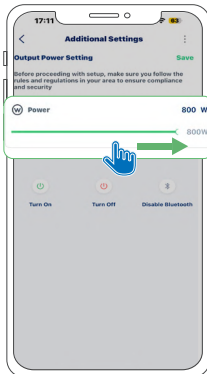

C)-2.

D) To set the load power curve,

- 1) Go to **Device settings** > **Home Load Setting** > **Load Power Curve**.
- 2) Tap the **Create** button.
- 3) Follow the on-screen instructions to set the specific amount of power that the device is required to supply to the load for each day and specific period within that day.



The Home load setting screen offers two options: Constant load power and Load power curve. You can only select one option at a time.

NOTICE

Load power curve setting provides more detailed control over power delivery throughout the day. It allows you to set load power values for specific days and periods. Please note that you can configure up to seven curves and only one curve can be applied per day.

We recommend configuring load power curves to maximize the use of solar energy generated by PV modules.

5.5 Checking the System Performance

A) Tap the **System** icon 

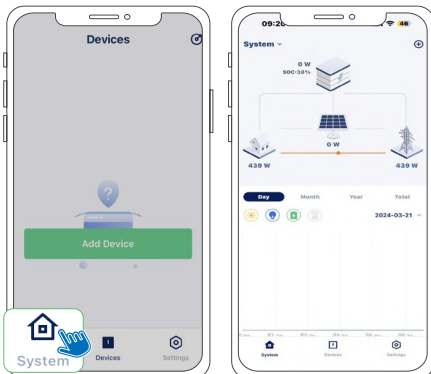

6. Storage and Maintenance

The following requirements should be met if the MS-A2 is not put into use directly:

- Keep the MS-A2 on a flat surface when storing it.
- Clean the MS-A2 and its components only with a cloth or a soft brush moistened with clean water.
- For the best preservation of battery life, charge it regularly. Even if you're not using the battery, periodically charge it every few months.
- Check the battery enclosure and connectors for damage or corrosion regularly to ensure it works properly.
- If you're storing the battery for a long time, charge the MS-A2 to 40%-50% at room temperature before storing it.

7. Safety Information

Please read all instructions carefully before using this product.

DANGER!

- PV modules produce DC electricity when exposed to light and can cause an electrical shock. Be aware of this.
- Do not exceed the MS-A2's output rating to prevent fire or injury. Overloading outputs above the rating may lead to fire or injury.
- Do not use the MS-A2 or any attachments if they are damaged or modified, as this may result in unpredictable behavior and pose a risk of fire, explosion, or injury.
- Do not operate the MS-A2 with a damaged cord, plug, or output cable.
- Keep the MS-A2 away from fire or high temperatures.
- Do not throw batteries into the fire. Batteries may explode in fire.

WARNING!

- Only use attachments recommended or sold by Hoymiles to prevent the risk of fire, electric shock, or injury.
- Do not attempt to disassemble the MS-A2. Seek help from a qualified service person for servicing or repairs to prevent the risk of fire or electric shock.
- Before performing any service, unplug the power pack from the outlet to reduce the risk of electric shock.
- Do not open or damage batteries, as released electrolytes may be toxic and harmful to skin and eyes.
- Do not use this product around strong static electricity or magnetic fields.
- Disconnect the entire system from the power source during installation.
- Do not put your fingers or hands into the MS-A2.
- Avoid misuse, dropping, or applying excessive force to prevent damage to the MS-A2.
- Shield the MS-A2 from direct sunlight to prevent rapid temperature increase.
- Keep the MS-A2 away from flammable, explosive gases, or smoke.
- The MS-A2 has an IP65 protection level and should not be submerged in liquids. If the MS-A2 accidentally falls into water, place it in a safe and open area to dry completely. Do not reuse the dried product.

 **CAUTION!**

- The MS-A2 is a Class 1 product and is required to be grounded for safety. But, since the MS plug-and-play cable already has a protective earth wire, you can simply use this cable for grounding without any additional steps.
- It is recommended to use a residual current-operated protective device (RCD) or a residual current monitor (RCM) of type B on the power supply side of this product.
- Before use, check the MS-A2 for any signs of damage, such as cracks, leaks, heat, or cable damage. If any abnormalities are detected, discontinue use immediately and contact our Technical Support Team.
- Battery servicing should be performed or supervised by a competent electrician who is knowledgeable about batteries and safety precautions.
- When replacing batteries, use the same type and number as the original. Follow these precautions:
 - Remove watches, rings, and other metal objects.
 - Use tools with insulated handles.
 - Wear rubber gloves and boots.
 - Keep tools and metal parts away from the batteries.
 - Disconnect the charging source before connecting or disconnecting battery terminals.
- Make sure the battery isn't accidentally grounded. If it is, disconnect the ground source. A grounded battery can cause electrical shock. To reduce this risk, remove any grounds during installation and maintenance. This rule applies to both equipment and remote battery supplies that don't have a grounded supply circuit.
- Ensure battery terminals and connectors are accessible for maintenance with the proper tools.
- Place batteries with liquid electrolytes so that the cell caps are accessible for testing and adjusting electrolyte levels.
- To minimize the risk of injury, closely supervise the MS-A2 when in use near children. Keep it out of reach of children and pets.
- Do not stand on the MS-A2.
- The MS-A2 must not be disposed of with other waste, and instead must be taken to the waste collection points for treatment, collection, recycling, and disposal.



Hoymiles Power Electronics Inc.



Headquarters

Floor 6, Building 5, Housheng 99 Road,
Gongshu District, Hangzhou 310015 P. R.
China

Europe Sales and Support Center

High Tech Campus 9, Unit BK3.28, 5656AE
Eindhoven, the Netherlands



+31 852736388 (English, German, French,
Polish, and Dutch Support)



[hoymiles.com](https://www.hoymiles.com)



Germany

service.de@hoymiles.com

Spain

service.es@hoymiles.com

Italy

service.it@hoymiles.com

France

service.fr@hoymiles.com

Netherlands

service.nl@hoymiles.com

Rest of the EU

service.eg@hoymiles.com